

FAZORTAN2

CONTROLLABLE SPACE PHASER



User Manual

Table of Contents

Requirements	3
Preliminary information	4
Overview	5
Signal flow	6
Basic modules	6
Phase shifter	6
LFO – Low Frequency Oscillator	8
Sweep section	9
Master section.....	10
The signal path	11
Preset Management	10
Preset storage.....	10
Browsing presets	11
Sources	12
Filter	12
Groups and tags.....	12
Results	13
Preset filtering using Groups and Tags	14
Basic Actions	14
Group operator.....	14
Filter enable / disable	15
Other types of filtering	15
Searching by name	15
Filtering Favorite presets.....	15
Filtering Pinned presets.....	16
Info pane	17
Browser’s visual adjustments.....	18
Folding sections.....	18
Resizing columns.....	18
Editing presets	19
Preset selection for Edit.....	19
Preset renaming	19
Preset deletion	20
Tags editing	20
Author editing	22
Description editing	22
Setting presets as Favorites	23
Pinning presets.....	23
Preset exchange.....	24
Export	24
Import	25
Importing Patterns	25

Creating custom Tags and Groups structure.....	25
Adding custom Tags	25
Editing custom Tags.....	26
Adding custom Groups	26
Editing custom Groups	27
Unassigned Tags	27
Configuration	28
MIDI Learn.....	28
Linking a parameter to MIDI CC	28
Unlinking a parameter from MIDI CC	29
Loading / Saving a MIDI CC Map.....	29
Quality settings	29
GUI	30
Size.....	30
System Scale	30
Theme	30
Default Settings	30
Changing default settings.....	30
Restoring factory defaults	31

Requirements

Software and hardware requirements of the product



Windows PC

OS version	Windows 7 or newer
CPU	2.0 GHz SSE (Multicore 2.4 GHz recommended)
RAM	8 GB (16 GB Recommended)
Software	VST2 / VST3 / AAX compatible host application (32bit or 64bit)



Apple Mac

OS version	OS X 10.13 or newer
CPU	Intel based 2.0 GHz (2.5 GHz recommended), Apple M1
RAM	8 GB (16 GB Recommended)
Software	AU / VST2 / VST3 / AAX compatible host application (64bit!)

Hardware requirements / recommendations are based on estimates performed on available computers at D16 Group HQ, and therefore cannot cover all possible configurations available on the market. CPU usage may vary widely depending on the manner in which the product is used. Factors that may contribute to variance in CPU usage include particular patch and its complexity, the global quality setting, project sample rate. In order to form a better understanding of how a plug-in will behave within your current setup, we highly recommend downloading the demo and giving it a try.

Preliminary information

This chapter contains general advice for using the plug-in's interface.

To do a right-click on macOS with single button mice:

Either use your **mouse click** while holding the **CTRL key** on your keyboard or use **two fingers** on your **touchpad**.

Checking the value of a parameter

Right-click on any parameter to check its value in its context menu:

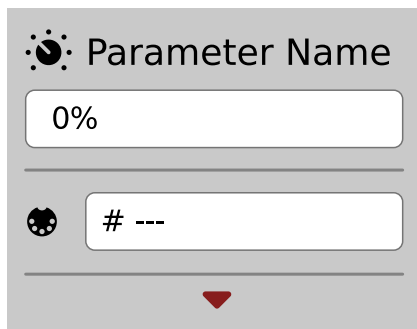

A parameter's context menu

Note: It's currently not possible to enter a precise value in the input box; it's just to check the value.

Fine-tuning continuous parameters

Tweak a control (knob) while holding the **CTRL key** (on **Windows**) or **Apple CMD** key (on **macOS**) - this will make the tweaking more precise while moving the mouse pointer up and down.

Double-click to reset a continuous parameter's value

Double-clicking on a parameter restores its value to the initial state, either default (right after loading the plug-in / loading it along a project file) or from the most recently loaded preset.

Overview

Fazortan 2 is a dual-LFO phaser effect.



Fazortan 2 graphical interface

The plugin interface comprises two main sections:

- **Configuration and preset management** (the top-most section)

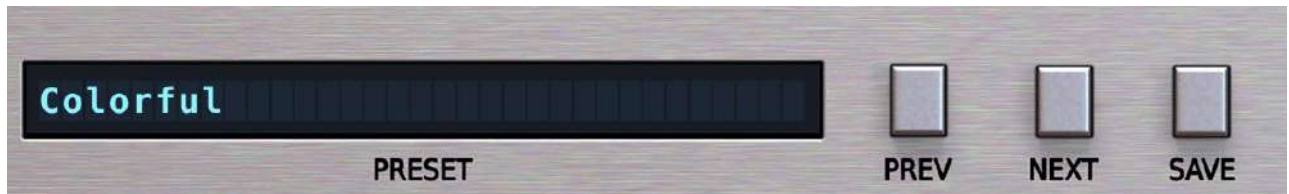

Configuration and preset management section

- **Signal processing** (all remaining controls)

Signal flow

In this chapter, we'll describe the signal path through **Fazortan 2**, and explain each component and its controls along the way.

Basic modules

Fazortan 2's signal processing components are organised into separate sections in the graphical user interface:

Phase shifter

At the heart of **Fazortan 2**, the phase shifter applies an all-pass filter to the input signal to generate a phasing effect. The frequency response of this filter can be thought of as like a series of notch filters with cutoff frequencies evenly spread across the spectrum. The **Phase shifter** is controlled in the **Phaser** section of the GUI:



The Phaser section

The **Phaser** section houses the following controls:

- **Stages** – Set the number of all-pass filters (**Stages**) making up the **Phase shifter** to **2, 4, 6 or 8**. The frequency responses of the phasing filter for all four options are illustrated below:

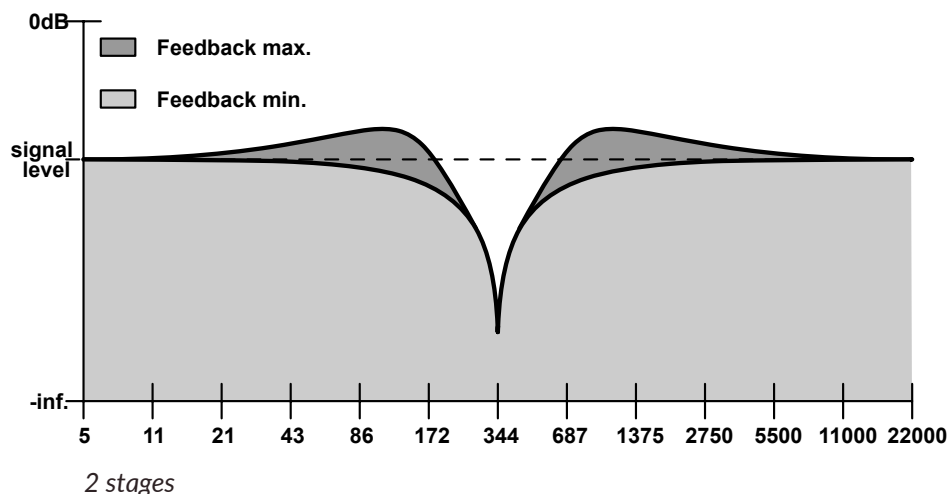

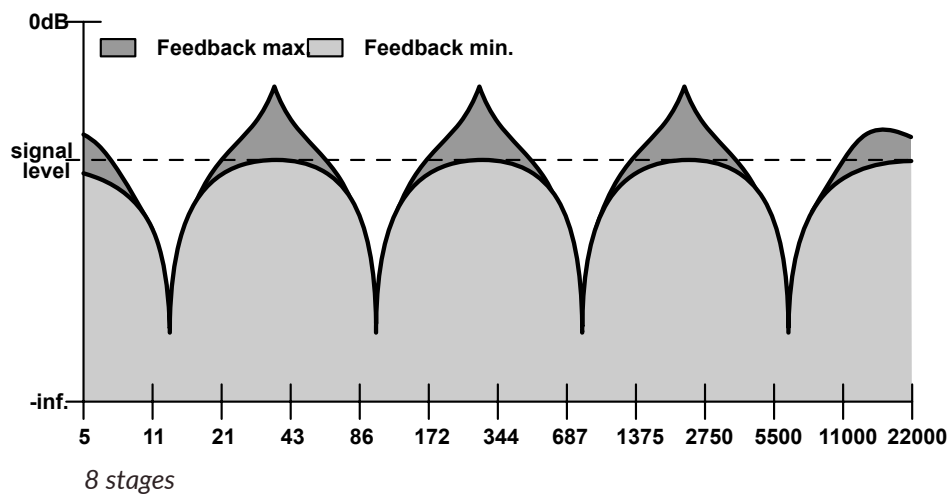
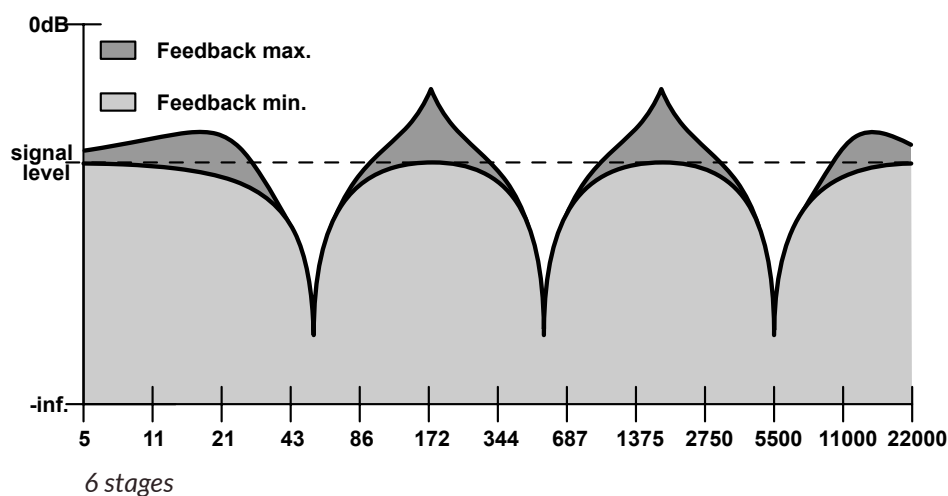
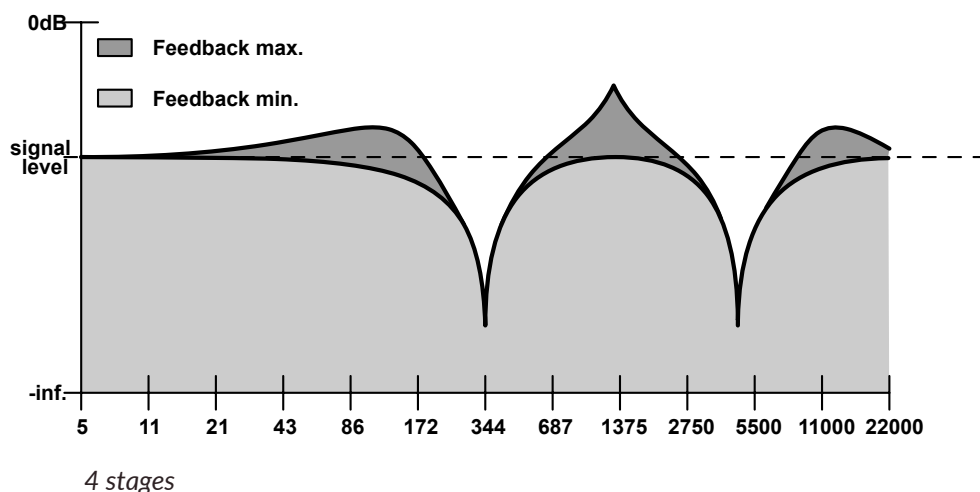

- **Center Frq.** - The **Phase shifter** stages (2, 4, 6 or 8) are evenly spread across the frequency spectrum, with the center point between them determining the main *operational* frequency. The **Center Frequency** control shifts that operational frequency up and down the spectrum, and can be modulated by **Fazortan 2's** two **LFOs** (*Low Frequency Oscillators*).
- **Feedback** – Route the **Phase shifter** output back into its input to emphasise the frequencies around the all-pass filter stage cutoff points.

- **Stereo phase** - The mixed waveform output by **Fazortan 2**'s two **LFOs** is stereo, and the **Stereo Phase** parameter applies phase shifting between the left and right channels.

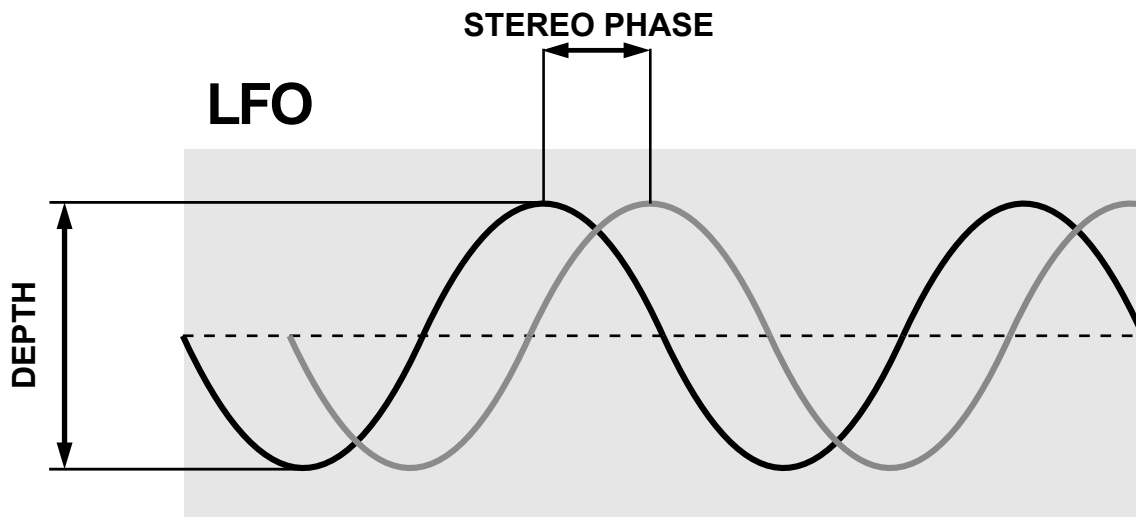

LFO phase shift between stereo channels

When **Stereo Phase** is at **0**, the left and right **LFO** waves are 100% in phase. As the **Stereo phase** knob is turned clockwise, the phases of the two channels begin to separate, the difference between them increasing as the parameter is raised. The result is obvious widening of the stereo effect.

LFO – Low Frequency Oscillator

Fazortan 2 features two *Low Frequency Oscillators*, the mixed output of which is used to modulate the **Center Frequency** of the **Phase Shifter**.



Low Frequency Oscillator

The two LFO sections are identical and comprise the following controls:

- **Waveform** – Choose one of seven waveform shapes: *triangle, sinus, hyper-triangle, sawtooth ascending, sawtooth descending, square and sample/hold*.
- **Rate** – Adjust the frequency of the **LFO**, from *0.01 Hz* to *20 Hz* with **Sync** disengaged.
- **Sync** – Engage to synchronize the **LFO** to the tempo set in the host application.
- **Scale** – Set the note value modifier for tempo synchronization mode (with the **Sync** button engaged):
 - **Full** – The **LFO** period length is equal to the note value set by the **Rate** knob at the host tempo.
 - **Dotted** – The **LFO** period length is equal to the dotted note value set by the **Rate** knob at the host tempo.
 - **Triplet** – The **LFO** period length is equal to the triplet note value set by the **Rate** knob at the host tempo.

When **Sync** is engaged, the **LFO Rate** can be set to one of the following values: **1, 2, 4, 8** or **16** bars; half note ($\frac{1}{2}$), quarter note ($\frac{1}{4}$), eighth note ($\frac{1}{8}$), 16th note ($\frac{1}{16}$) or 32nd note ($\frac{1}{32}$).

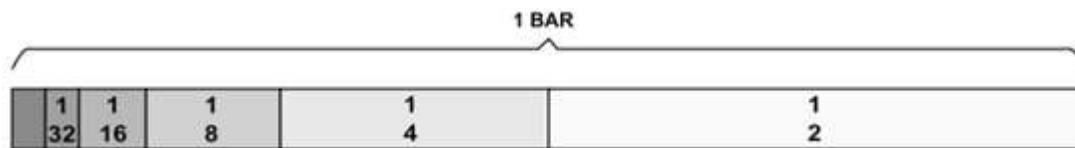

One bar

A **Dotted** note is half a note longer than a **Full** note, while a **Triplet** note is two thirds the length of a **Full** note.

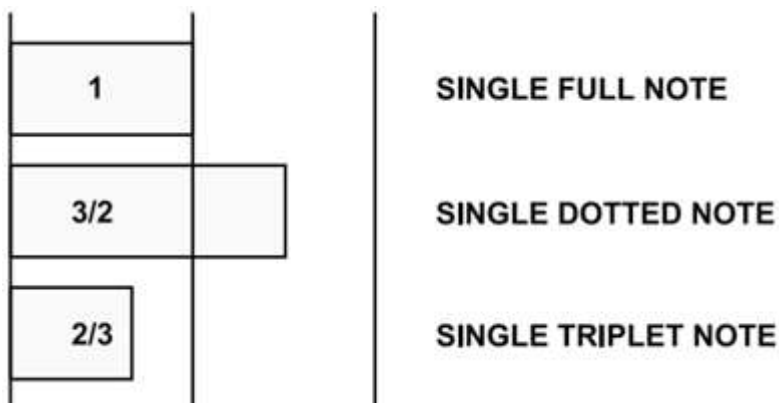

Note lengths

The waveforms generated by **Fazortan 2's** two **LFO** modules are mixed (added) together, and the resultant oscillation modulates the operational frequency (**Center Frq.** parameter) of the **Phase shifter**.

Sweep section

The **Sweep** controls govern the amplitudes of the waveforms generated by **LFO1** and **LFO2**:



The Sweep section

The **LFO 1 Depth** and **LFO 2 Depth** controls set the amount of effect that the oscillations of each **LFO** have on the **Phase shifter's** center frequency.

Master section

At the end of the signal flow, the **FX** knob controls the balance of processed/unprocessed sound sent to the output, while **Output Volume** determines the final amplification level.



The Master section

The signal path

The diagram below shows the signal flow through **Fazortan 2**:

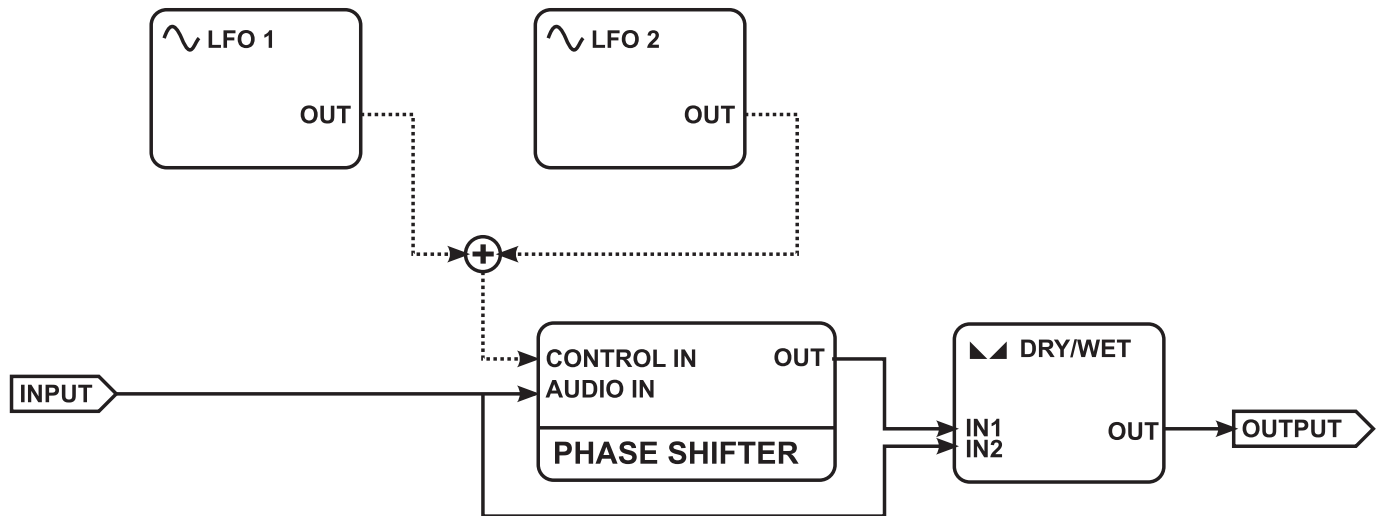

Signal flow

In summary, the signal is duplicated immediately after the input and sent down two paths: one goes to the **Phase shifter**, the other goes straight to the output on the 'Dry' channel. The operational frequency (**Center Frq.**) of the all-pass filter in the **Phase shifter** is modulated by the two **LFOs**. At the end of the signal path, the processed (**Wet**) and unprocessed (**Dry**) signals are mixed using the **FX** knob.

Preset Management

Preset storage

Presets, both from **Factory** content and user ones, are stored as files in proper locations on the disc. Each time a plug-in instance is loaded into a project, these locations are scanned and the presets found there are consolidated into a single linear structure (list) in the **Preset Browser**.

Browsing presets

The **Preset management section** (no matter what kind of preset it concerns) enables quick navigation and browsing of the preset structure:



The Preset management section

- **PRESET** - Displays the name of the currently loaded preset. Clicking the display opens the **Preset Browser** panel, allowing you to browse factory / user presets.
- **Prev / Next** - Hovering over right side of the **Preset** display exposes the **Prev / Next** buttons: They allow for linear browsing of the presets list (depending on currently set filters - see sections below).
- **Save** - Saves current parameters as a new preset or allows for overwriting of the existing one (see sections below).

Right-clicking over the **Preset** display opens a context menu with two or three additional options:

- **Init** - Restores initial settings of plug-in parameters.
- **Reload** - Reloads the most recently loaded preset.
- **Save** - See description above.

The **Preset Browser** looks as follows:

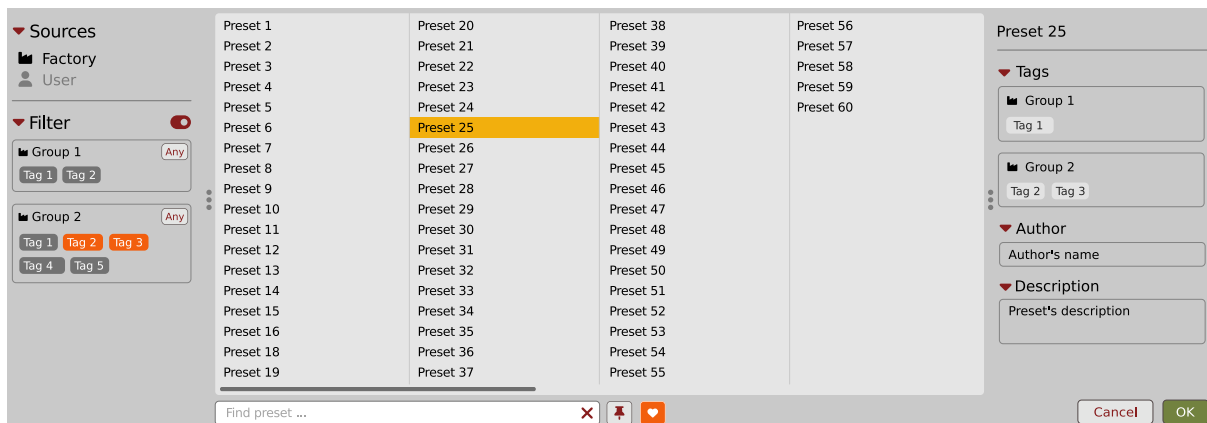

The Preset Browser

There are four main parts:

- **Sources** - Situated in the left column, filter content **Sources** for displayed presets.
- **Filter** - Below **Sources**, a preset **Filter** that uses the **Tags** system.
- **Results** - List of presets (shown in the middle column) from **Sources** that meet criteria set in the **Filter**.
- **Info pane** - The right column shows information about the currently selected preset(s), divided into several subsections.

If available - For some preset types this button can be hidden and accessible from the contextual menu (accessible via right mouse-click on **Preset display**)
 If available

Sources

In this section, you can choose a **Source** / **Source(s)** that you want to browse presets from.

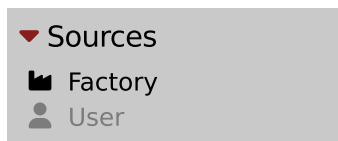

Preset Sources

There are two resources to choose from:

- **Factory** - Delivered together with the plug-in and cannot be modified (read-only).
- **User** - Created by the user and can be freely modified or shared with other users.

Choosing any of them will cause the results to narrow to the presets from one resource.

Filter

The section below is the **Filter**, which represents a preset filtering system using **Groups** and **Tags** to browse the content.

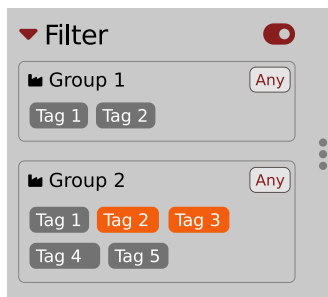

The Filter section

Groups and tags

Each **Preset** is described by a few common **Groups**. Within each of them there may be one or more **Tags** from a particular set.

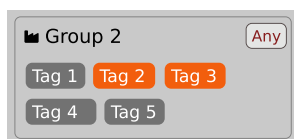

The Filter group

Presets from the **Factory** resource were assigned **Groups** and **Tags** when they were created.

Groups and **Tags** describe the content clearly, taking into account the plug-in's purpose.

Editing of the **Groups** and **Tags** for **Factory** content is limited. User presets can be described with the same **Groups** and **Tags** as **Factory** content, or you may define additional **Tags** within factory **Groups** and even create your own **Groups** with your own **Tags** to describe your own presets.

The only limitation is that a user cannot remove factory **Groups** or **Tags** from **Factory** content.

Results

This is a list of presets from chosen **Sources** that meet the filtering criteria. The basic function of this section is to browse and load presets. It can also be used for editing, which is described later.

Preset 1	Preset 20	Preset 38	Preset 56
Preset 2	Preset 21	Preset 39	Preset 57
Preset 3	Preset 22	Preset 40	Preset 58
Preset 4	Preset 23	Preset 41	Preset 59
Preset 5	Preset 24	Preset 42	Preset 60
Preset 6	Preset 25	Preset 43	
Preset 7	Preset 26	Preset 44	
Preset 8	Preset 27	Preset 45	
Preset 9	Preset 28	Preset 46	
Preset 10	Preset 29	Preset 47	
Preset 11	Preset 30	Preset 48	
Preset 12	Preset 31	Preset 49	
Preset 13	Preset 32	Preset 50	
Preset 14	Preset 33	Preset 51	
Preset 15	Preset 34	Preset 52	
Preset 16	Preset 35	Preset 53	
Preset 18	Preset 36	Preset 54	
Preset 19	Preset 37	Preset 55	

The Results list

- **Click** any name to choose and load the preset.
- **Double-click** the name to choose, load the preset and close the browser.

Hitting the **OK** button confirms loading a preset and closes the browser. Using **Cancel** closes the browser but reverts all parameter changes that loading a new preset might have caused.

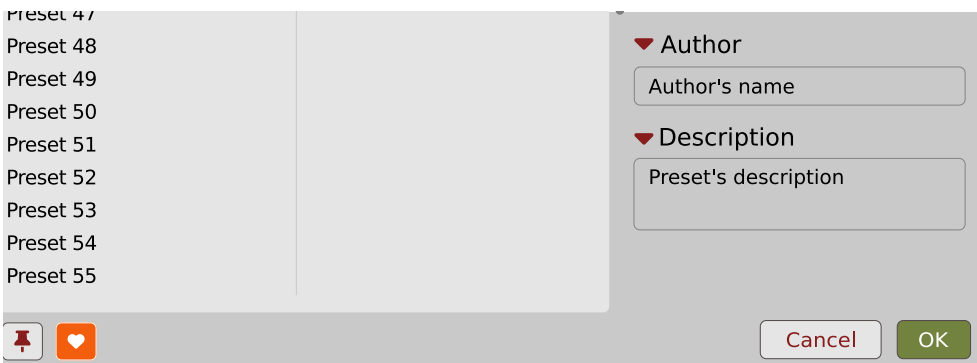

The OK and Cancel buttons in the browser

Using the **X** icon has the same effect as the **OK** button:

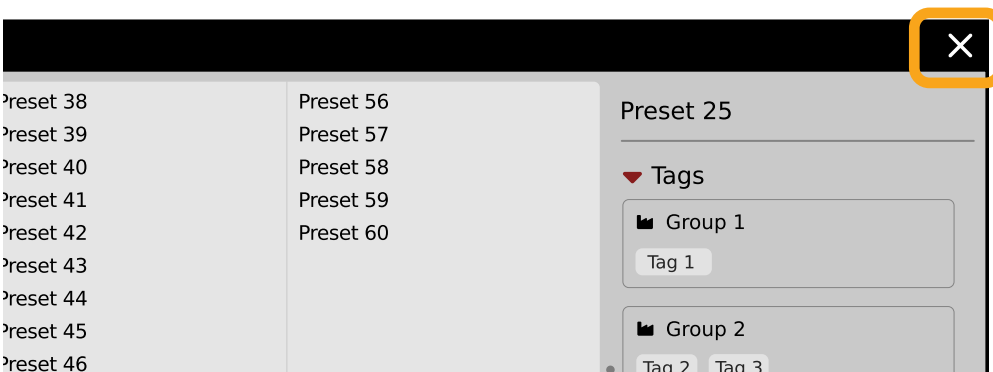

Close Browser window

Preset filtering using Groups and Tags

The **Filter** section contains **Groups** of **Tags**. Each Group is represented by a rectangle with the **Group** name + set of **Tags** inside.

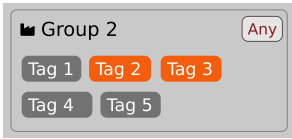

Group 2 with two tags set (Tag 2 and Tag 3)

The filtering process cascades from top to bottom. This means that all presets available in the selected **Sources** are filtered by selected **Tags** from the first **Group** (uppermost one), then the **Group** below and so on, until filtered by the last active **Group** (the bottom one).

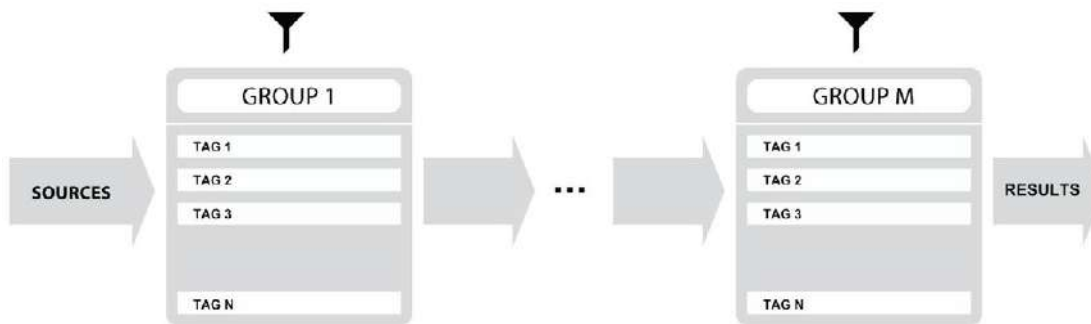

Preset Filtering with the use of Groups

The result of the cascade filtering process is listed in the middle column, the **Results** / presets list section. You can also consider the **Results** list as an intersection of preset sets, found by filtering through every individual **Group**.

Basic Actions

Tags work as toggle buttons. Click to *activate* / *deactivate* a **Tag**; a gray background color means that the **Tag** is inactive, and orange means that the **Tag** is *active*.

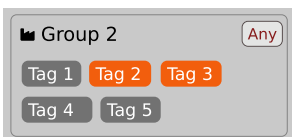

Group 2 with two tags set (Tag 2 and Tag 3)

If at least one **Tag** in a **Group** is active, then the **Group** (filter) also becomes active, otherwise the **Group** chosen doesn't affect the filtering process at all.

Group operator

When a single **Tag** is active in a **Group**, only presets having that **Tag** set are displayed in the **Results**.

If two or more **Tags** in a **Group** are active, the **Results** depend on the **Operator** chosen for the **Group**:

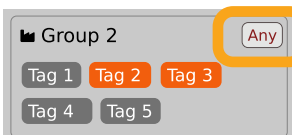

A Group operator

The **Operator** button works in toggle mode and offers a choice of two alternative **Operators** for the **Group**:

- **Any** - Means that a preset is shown in the **Results** when the preset includes at least one of the active **Tags** from the **Group**.
- **All** - Means that a preset is shown in the **Results** only when the preset includes all active **Tags** from the **Group**.

Filter enable / disable

You can quickly enable / disable the **Filter** using the toggle switch in the top-most section of the **Filter**:

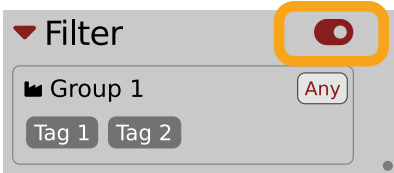

An On/Off switch for a Group Filter

Other types of filtering

Searching by name

Alternatively, you can look for a preset by entering its name or just a piece of its name into the **Find preset** field:



The Find preset input

The **Results** are refreshed on-the-fly and they work together with the other filters.

Using the **X** icon clears the entire field:



Clearing the search field

Filtering Favorite presets

You can mark presets as a **Favorite** by clicking the **Heart** icon while hovering on preset name . You can unmark presets by clicking the icon again (toggle mode):



Setting a preset as a Favorite on the list

- Logical OR between Tags in the Group
- Logical AND between Tags in the Group
- It's allowed for every **source** (**factory** or **user**)

The flag is stored globally, meaning that a **Favorite** preset will be accessible as such from every other instance of the plug-in 📌.

Once you have your **Favorite** presets flagged, you can quickly filter them using the toggle button with a **Heart** icon on it:



Favorite presets filtering

If the button is active, then only **Favorite** presets will be shown (considering all remaining filters).

Filtering Pinned presets

You can **Pin** one or more presets using the **Pin** icon while hovering over a preset name 📌. You can unpin a preset by clicking the icon again (toggle mode):

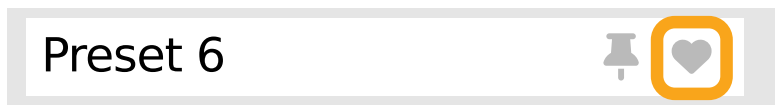

Pinning a preset on the list

Unlike **Favorites**, this flag works locally and it's stored with the project file (not global config), so **Pins** are stored individually for every instance (with total recall, so a plug-in state is recalled if saved in the context of a project).

But, similarly to **Favorites**, you can easily filter presets using the toggle button with the **Pin** symbol on it:



Pinned presets filtering

If the button is active, then only **Pinned** presets will be shown (considering all remaining filters).

Info pane

The column to the right shows information about the selected preset or presets. It also provides access to some of the preset editing functions.

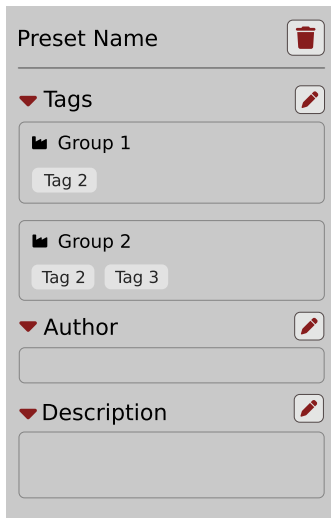

The Info pane

There's a preset name at the top.

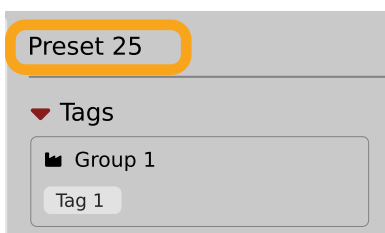

The Preset name in the Info pane

Additionally, if you've selected more than one preset there's information about how many more have been selected:

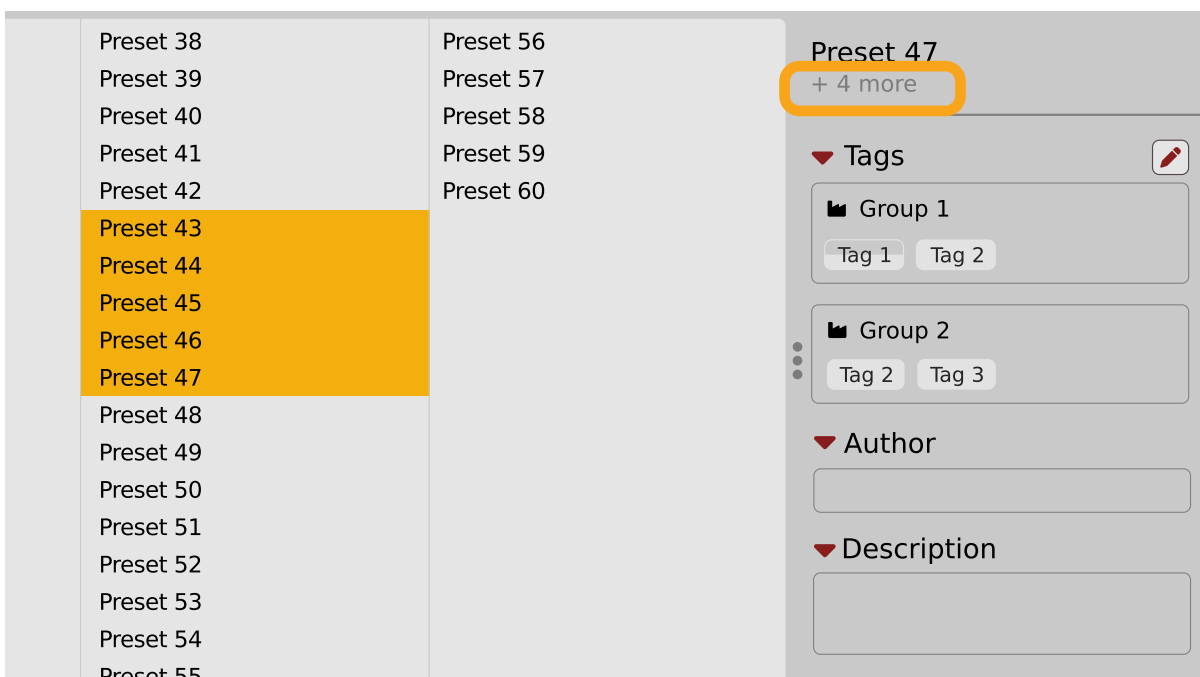

Selecting more than one preset

Below the preset(s) name there are few common sections describing selected presets:

- **Tags**
- **Author**
- **Description**

Browser's visual adjustments

Folding sections

If you don't need to see the contents of every section / subsection, you can fold some of them up using the **Caret** icons:

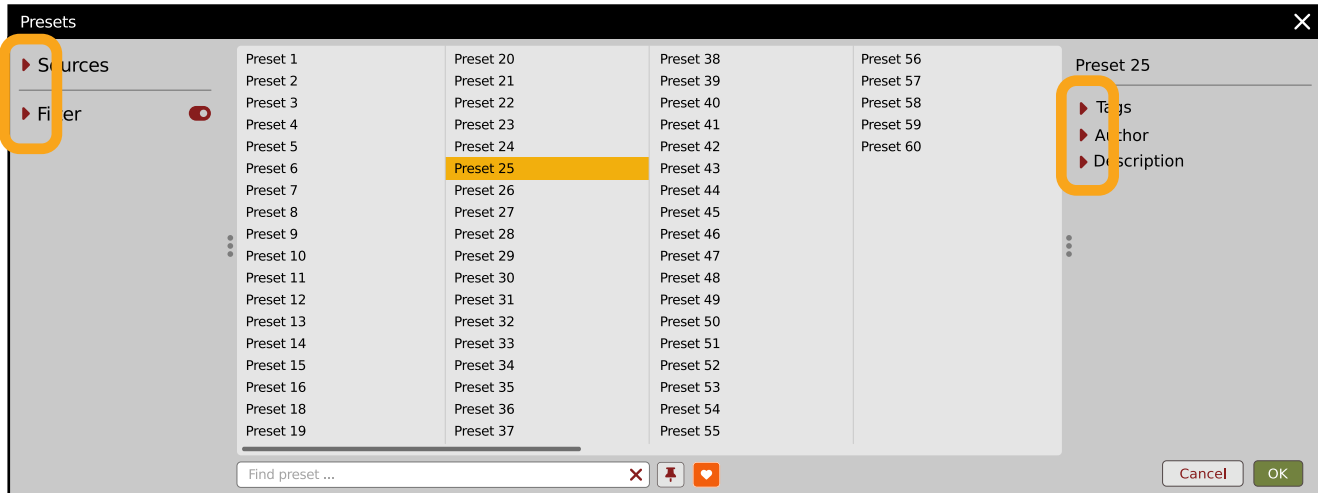

Sections folded up

Resizing columns

You can use the three-dotted handles to change a column's width to your preference.

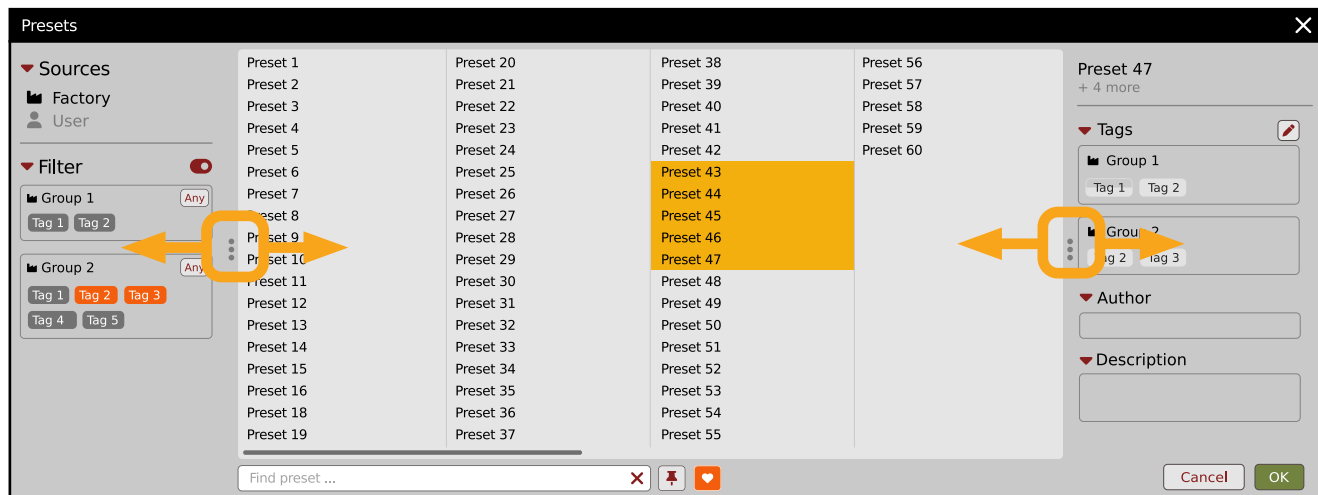

Resizing Browser columns

Editing presets

You can perform certain actions on presets, such as adjusting **Groups** and **Tags**, deletion, renaming the presets as well as their export or import. One should bear in mind, however, that some operations are only allowed on user presets but not on **Factory** content.

Preset selection for Edit

Some operations can be done on more than one preset, so you're allowed to select more than one preset at once; in the **Results** section, you can choose a preset or a set of presets in the following ways:

- **Click a preset** - Selects (and loads) one preset from the list.
- Win (**Ctrl**) + **Click the preset**), Mac (**Cmd**) + **Click the preset**) - Adds another preset to an already chosen preset or a set of presets.
- **Shift + Click the preset** - Selects a range of presets from the last chosen preset to the preset clicked with the *Shift* key.
- Right-Click on any **Preset** in the **Results** section and choose the **Select All** option - this selects all presets:

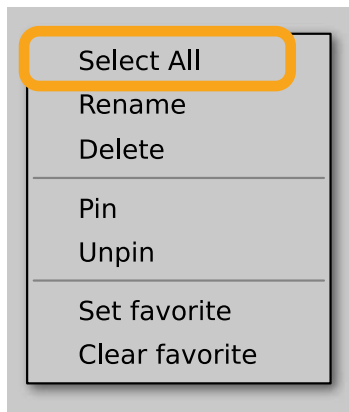

Selecting all presets

Preset renaming

On a selected preset **▶**, right-click to open the context menu and select the **Rename** option:

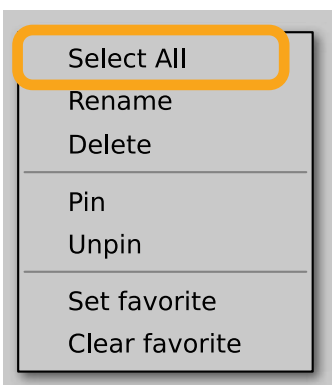

Preset renaming

▶ The option is available only for individual presets and won't work on a selection of two or more presets.

Preset deletion

Once you have selected one or more presets, right-click to open the context menu and select the **Delete items**  option:

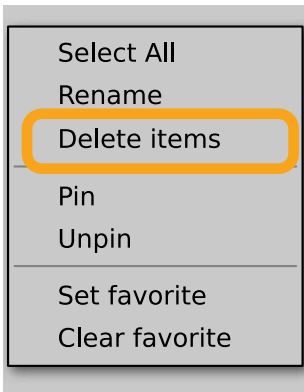

Deleting presets

Alternatively, you can use the **Trash bin** button in the **Info pane** to delete selected presets:



The Trash bin button

Tags editing

When you select a preset or presets to change their tags, click the **Pencil** button next the **Tags** section in the **Info pane** to enter **Edit mode** for the **Tags**:

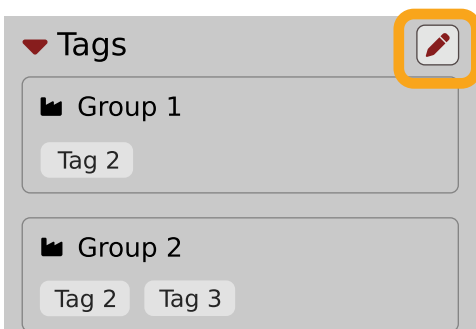

Entering the Tag edit mode

 Or **Delete** option (depending on how many presets have been selected).

With the **Edit mode** enabled, you will see all possible **Groups** and **Tags** available for the preset(s):

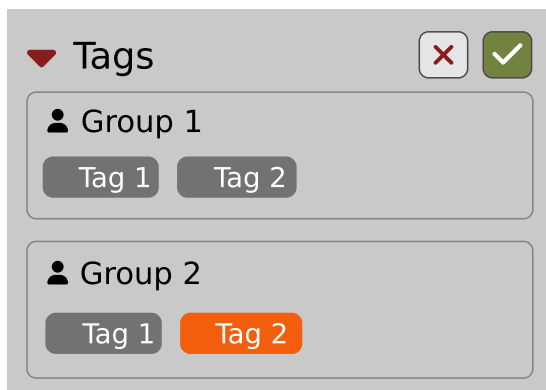

The Tag Edit mode

Tag buttons work in toggle mode, much like filtering. Clicking them either sets or erases a **Tag** for a chosen preset. If a **Tag** is set for a preset, it is indicated by an orange background color, whereas if a **Tag** is not set, it has a gray background color.

If you choose multiple presets with existing tags, **Tag** buttons will appear orange if a specific **Tag** appears in all selected presets, and gray if it appears in none.

When a specific **Tag** is set only for a few of the selected presets, it appears as half-gray and half-orange.

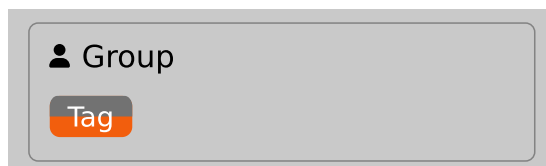

Tags appearing only in part of selection

Changing the **Tag** status for one or more chosen presets sets or erases this **Tag** in all these presets. A status change is signaled by an **Asterisk** to the left of a **Tag**.



A Tag with a status change

Tag buttons highlighted in half-gray and half-orange color (where **Tag** values across the highlighted presets aren't all the same) work in a three-state system when switching between states; they turn gray if you erase the **Tag** for all selected presets, orange if you set the **Tag** for all selected presets, and return to half-gray and half-orange if the selected items remain unchanged or are returned to their initial state.

Potential changes have to be confirmed using the **OK / Cancel** buttons at the top part of the **Tags** section:



Confirmation buttons in the Tags section

Author editing

When you select a preset or presets to change the **Author**, click the **Pencil** button next the **Author** section in the **Info pane** to enter the **Edit mode** for the **Author** field:

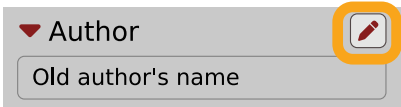
 A screenshot of a user interface element. At the top, there is a grey header with a downward-pointing triangle and the text "Author". To the right of this header is a small square button containing a pencil icon, which is highlighted with a yellow circle. Below the header is a text input field containing the text "Old author's name".

Editing Author

Once you've finished editing the field, confirm the operation using the **OK / Cancel** buttons:

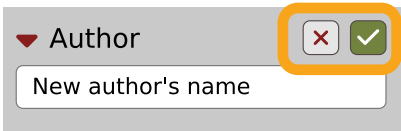

 A screenshot of the same user interface element as above, but now in a confirmation state. The text input field now contains "New author's name". To the right of the input field, there are two buttons: a square button with a red 'X' icon and a square button with a green checkmark icon. Both buttons are highlighted with a yellow circle.

Confirming Author editing

This operation is possible for user content only.

Description editing

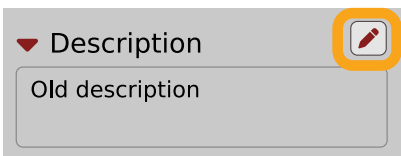
When you select a preset or presets to change the **Description**, click the **Pencil** button next the **Description** section in the **Info pane** to enter the **Edit mode** for the **Description** field:

 A screenshot of a user interface element. At the top, there is a grey header with a downward-pointing triangle and the text "Description". To the right of this header is a small square button containing a pencil icon, which is highlighted with a yellow circle. Below the header is a text input field containing the text "Old description".

Editing Description

Once you've finished editing the field, confirm the operation using the **OK / Cancel** buttons:

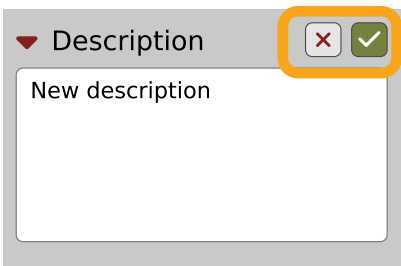
 A screenshot of the same user interface element as above, but now in a confirmation state. The text input field now contains "New description". To the right of the input field, there are two buttons: a square button with a red 'X' icon and a square button with a green checkmark icon. Both buttons are highlighted with a yellow circle.

Confirming Description editing

This operation is possible for user content only.

Setting presets as Favorites

As described in the chapters above, you can mark a preset as a **Favorite** by clicking the **Heart** icon while hovering over the preset name:



Setting a preset as a Favorite

The flag is stored globally, meaning that a **Favorite** preset will be accessible as such from every other instance of the plug-in ▶ .

It's also possible to perform the operation for a selection of presets. After you select the desired presets in the **Results** window, right-click on the presets to open a context menu:

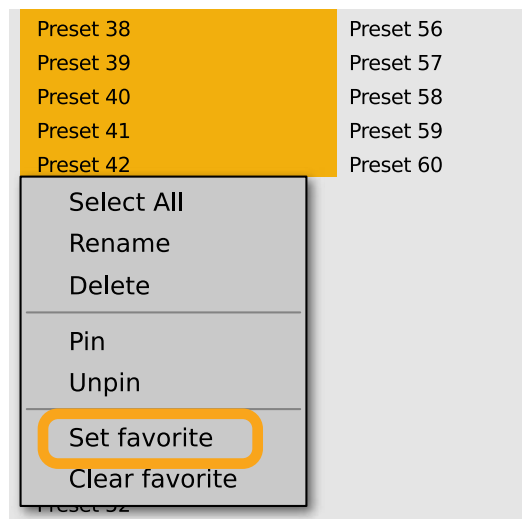

Setting Favorite presets from the context menu

And select the **Set favorite** option.

To clear **Favorite** flags for the selection of presets, use the **Clear favorite** option instead.

Pinning presets

You can **Pin** one or more presets using the **Pin** icon while hovering over the preset name:



Pinning a preset

Unlike **Favorites**, this flag works locally and it's stored with the project file (not globally). This means the **Pins** are stored individually for every instance (with total recall, so a plug-in state is recalled if saved in the context of a project).

▶ Sometimes a project or plug-in reload may be required

It's also possible to perform the operation for a selection of presets. After selecting the desired presets in the **Results** window, right-click on the presets list to open the context menu:

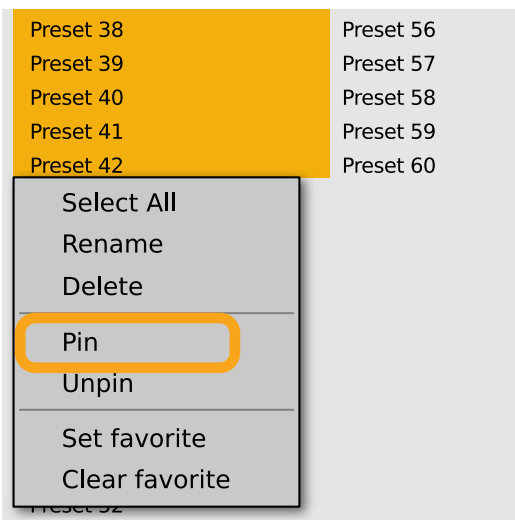

Pinning presets from selection

And select the **Pin** option.

To clear the **Pin** flag for a selection of presets, use the **Unpin** option instead.

Preset exchange

If you want to make a backup, or exchange a preset with a collaborator, you can export / import selected presets.

Export

Select a preset or presets that you're going to export and drag-and-drop them outside your DAW into a location you'd like to store them:

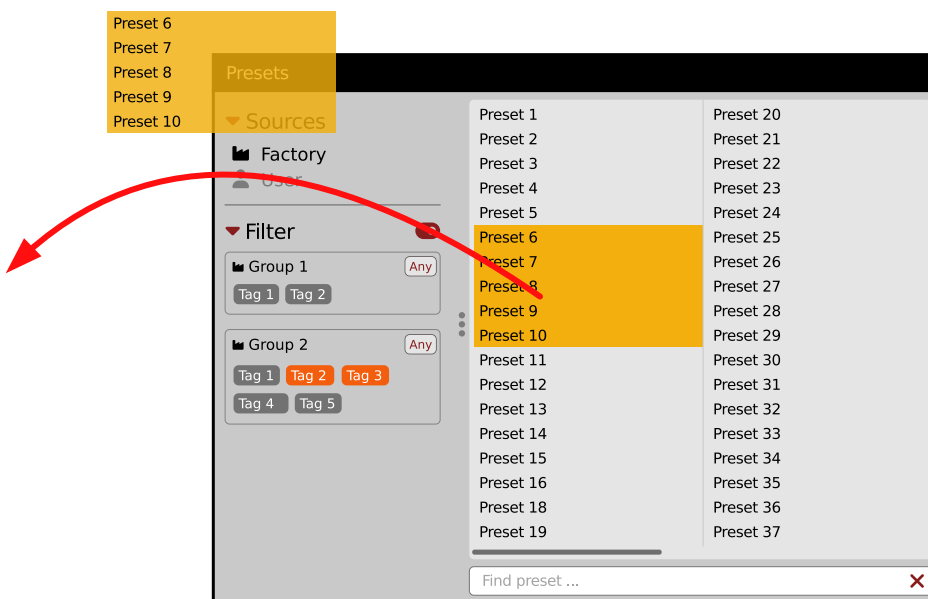

Exporting presets

The presets will be saved as individual files (one per preset) in the plug-in's native format.

Import

If you'd like to import preset files, you can drag-and-drop preset files from where they're stored, into the preset browser:

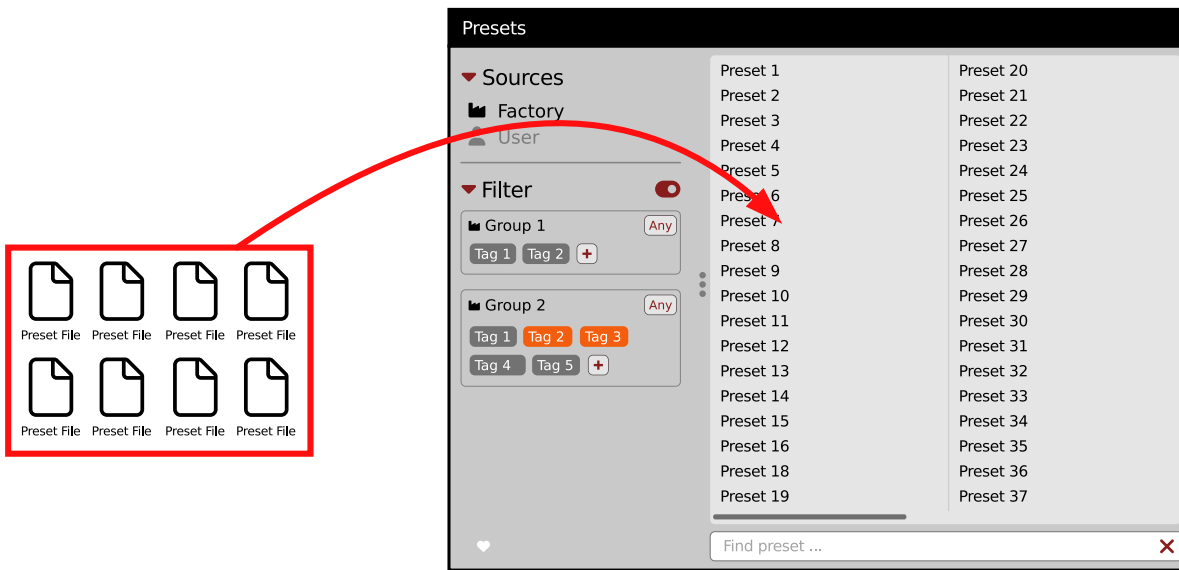

Importing presets

They will be automatically imported as user presets.

Importing Patterns

Specifically within the **Pattern browser**, it's possible to import:

- Native **Phoscyon 2** patterns.
- Banks from legacy versions of the plug-in (**Phoscyon 1.x**) - which will be accessible as alternative **Sources**, after you drag-and-drop them into the **Browser**.
- Patterns from *Audiorealism ABL 2* or *3* instruments - which will be included in **User** patterns after import.

Creating custom Tags and Groups structure

Adding custom Tags

Users are allowed to add their own custom **Tags** to both their own content and factory content. To add a new **Tag** to an existing filter **Group**, click over the **Group's** name to pull down a menu and select the **Add Tag** option .

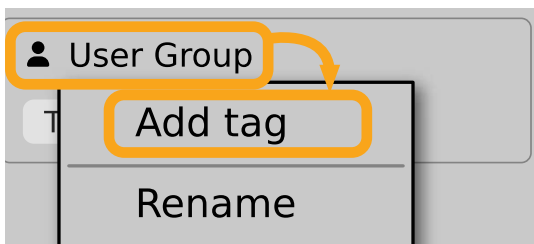

Adding a new Tag

You can do this either in the **Info Pane** (right column, while the **Tag edit** mode is enabled) or **Filter** (left column).

 This operation is allowed for a user's Groups only

Editing custom Tags

There are a few edit options available for a user to perform on their own **Tags**, which are available by right-clicking a **Tag's** name in the **Filter** section:

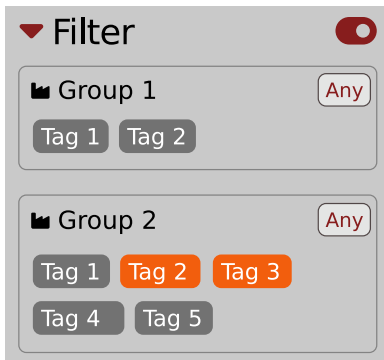

The Filter section

You will see a context menu with all the available options:

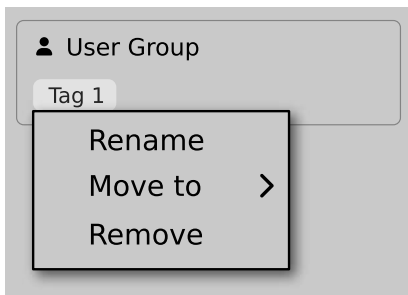

Editing options for a user Tag

- **Rename** - Changes the name of a **Tag**.
- **Move to** - Moves a **Tag** to another **Group**.
- **Remove** - Deletes a **Tag**.

The menu is accessible only for a user's own **Tags**.

Adding custom Groups

You can add a custom filter to **Groups** by clicking the **Filter** label and selecting the **Add Group** option from the pull-down menu:

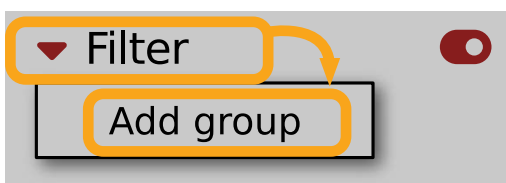

Adding a user Group

From here, you can add **Tags** to that newly created **Group** (see above), or move **Tags** from other **Groups**.

You can also add a custom filter to **Groups** in the **Info Pane** (right column) or **Filter** (left column).

Editing custom Groups

There are a few edit options available for a user to perform on their own **Groups**. Click on a **Group's** name in the **Filter** section:

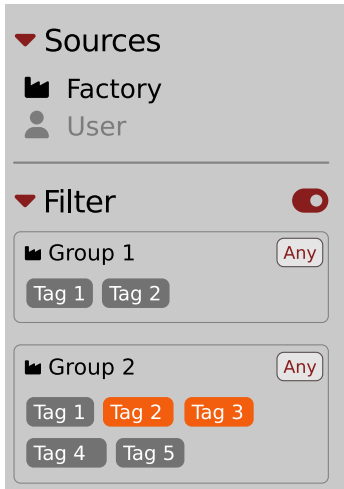

The Filter section

You will see a context menu with the following options:

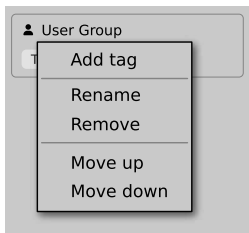

Edit options for a user Group

- **Add Tag** - Adds a new tag to the **Group** (described earlier).
- **Rename** - Changes the **Group's** name.
- **Remove** - Deletes the **Group**, possible only when all **Tags** in the **Group** have also been removed.
- **Move up** - Moves a **Group** up in the **Filter**. Possible unless the **Group** is already the topmost one.
- **Move down** - Moves a **Group** down in the **Filter**. Possible unless the **Group** is the last one.

These operations are possible only on user **Groups**.

Groups in the **Filter** are ordered with **Groups** from **Factory** content first, then user groups below.

You can edit user **Groups** in either the **Info Pane** (right column, while **Edit mode** for **Tags** is enabled) or **Filter** (left column).

Unassigned Tags

When you receive content from a collaborator who uses different **Tags** and **Groups**, some Tags may show as **Unassigned**. This happens if the filter structure made by a preset's author is different.

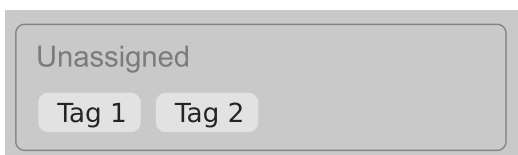

Unassigned Tags

You can move the **Tags** across your **Groups** to make them fit your scheme, or re-tag the collaborator content entirely.

Configuration

MIDI Learn

Right-click any plug-in parameter to open the context menu:

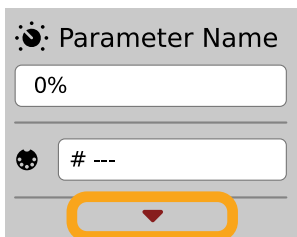

A context menu

Left-clicking outside the menu area closes it automatically.

Clicking the bottom arrow expands the menu and displays all available options:

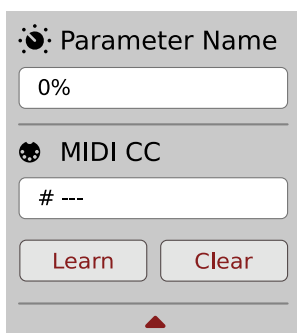

An expanded context menu

Linking a parameter to MIDI CC

The **Learn** function enables a quick assignment of physical controllers (from a MIDI controller) to plug-in parameters.

1. Click the **Learn** button to put the plug-in into a pending state before moving any MIDI CC controller.
2. Once the CC is recognized, click **OK** to save the change or click the **Cancel** button to restore the previous setting.

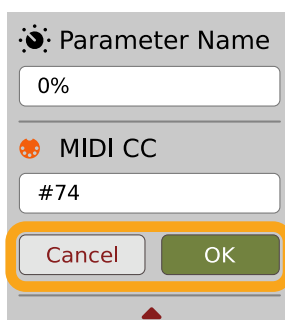

Linking a parameter to MIDI CC

Unlinking a parameter from MIDI CC

You can also delete a MIDI CC code attributed to a parameter from the context menu:

1. From the context menu, click the **Clear** button:

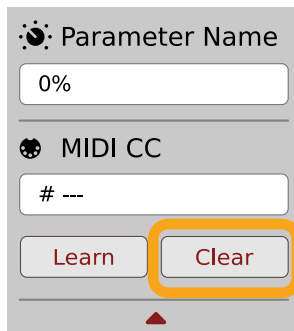

The Clear MIDI CC button

2. Then confirm using the **OK** button.

Loading / Saving a MIDI CC Map

These options are available in the **MIDI** submenu, accessible under **Cog** icon in the left-upper corner:

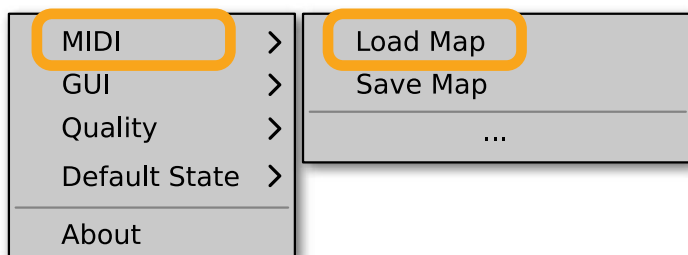

The Load Map and Save Map options

- **Save Map** - Saves the current MIDI CC map to a file.
- **Load Map** - Loads a MIDI CC map from a stored file.

Quality settings

The **Quality** submenu under **Cog** icon in upper-left corner allows to choose sound quality for **Real-time** or **Offline** modes.

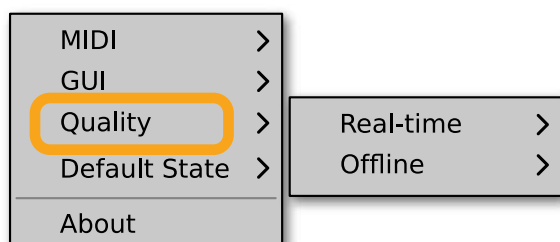

Quality settings

The higher the quality, the bigger the impact on the CPU.

GUI

The **Size**, **System Scale** and **Theme** options are accessible from **GUI** submenu under **Cog** icon in upper-left corner of the plug-in. With these, you can adjust look of the plug-in, according to the pixel density and resolution of your screen:

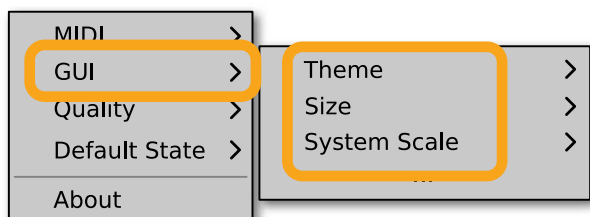

The GUI Size and System Scale options

Size

This option lets you choose one of several default skin sizes to best match the plugin to the resolution of your computer monitor.

System Scale

System Scale controls the rescale factor for the whole plug-in. For the best visual results, you should set it to the exact value from your system settings (screen properties).

Theme

The **Theme** allows you to choose skin color variant according to your preference

Default Settings

You can save your current settings so that the plug-in will default to them for each new instance, or restore the plug-in to load with its factory settings.

Changing default settings

1. Click the **Cog** icon in the left-upper corner of the plugin.
2. Go to the **Default State** submenu and choose the **Save current** option.

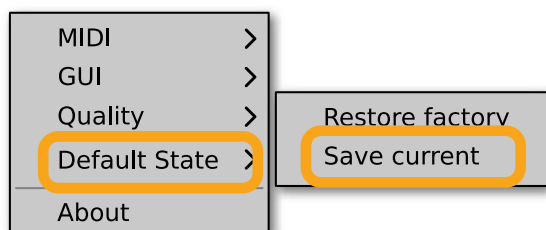

Changing the default state of the plug-in

With this option, the current plug-in state will be saved as the default / initial state for when you insert a new instance of the plug-in.

The plug-in state includes: sound parameters (default preset), views, preset filters, sound quality settings, loaded / created MIDI CC map and GUI settings.

Restoring factory defaults

To return the default state for new instances to factory settings:

1. Click the **Cog** icon in the left-upper corner of the plugin.
2. Go to the **Default State** submenu and choose the **Restore factory** option.